



April 2019

Series-Parallel Operations with Alpha-Graphs

Christian Barrientos

Valencia College, chr_barrientos@yahoo.com

Sarah Minion

Valencia College, sarah.m.minion@gmail.com

Follow this and additional works at: <https://digitalcommons.georgiasouthern.edu/tag>



Part of the [Discrete Mathematics and Combinatorics Commons](#)

Recommended Citation

Barrientos, Christian and Minion, Sarah (2019) "Series-Parallel Operations with Alpha-Graphs," *Theory and Applications of Graphs*: Vol. 6 : Iss. 1 , Article 4.

DOI: 10.20429/tag.2019.060104

Available at: <https://digitalcommons.georgiasouthern.edu/tag/vol6/iss1/4>

This article is brought to you for free and open access by the Journals at Digital Commons@Georgia Southern. It has been accepted for inclusion in Theory and Applications of Graphs by an authorized administrator of Digital Commons@Georgia Southern. For more information, please contact digitalcommons@georgiasouthern.edu.

Abstract

Among difference vertex labelings of graphs, α -labelings are the most restrictive one. A graph is an α -graph if it admits an α -labeling. In this work, we study a new alternative to construct α -graphs using, the well-known, series-parallel operations on smaller α -graphs. As an application of the series operation, we show that all members of a subfamily of all trees with maximum degree 4, obtained using vertex amalgamation of copies of the path P_{11} , are α -graphs. We also show that the one-point union of up to four copies of $K_{n,n}$ is an α -graph. In addition we prove that any α -graph of order m and size n is an induced subgraph of a graph of order $m + 2$ and size $m + n$. Furthermore, we prove that the Cartesian product of the bipartite graph $K_{2,n}$ and the path P_m is an α -graph.

1 Introduction

A *difference vertex labeling* of a graph G of size n is an injective mapping f from $V(G)$ into a set N of nonnegative integers, such that every edge uv of G has assigned a *weight* defined by $|f(u) - f(v)|$. The labeling f is called *graceful* when $N = \{0, 1, \dots, n\}$ and the set of induced weights is $\{1, 2, \dots, n\}$. If this is the case, G is called a *graceful graph*. Let G be a bipartite graph and $\{A, B\}$ be the natural bipartition of $V(G)$, we refer to A and B as the *stable sets* of $V(G)$ and assume that $|A| = a$ and $|B| = b$. A *bipartite labeling* of G is an injection $f : V(G) \rightarrow \{0, 1, \dots, s\}$ for which there is an integer λ , named the *boundary value* of f , such that $f(u) \leq \lambda < f(v)$ for every $(u, v) \in A \times B$, that induces n different weights. This is an extension of the definition of bipartite labeling given by Rosa and Širáň [14]. From the definition we may conclude that $s \geq |E(G)|$; furthermore, the labels assigned by f on the vertices of A and B are in the sets $\{0, 1, \dots, \lambda\}$ and $\{\lambda + 1, \lambda + 2, \dots, s\}$, respectively. If $s = n$, the function f is an α -labeling and G is an α -graph. If f is an α -labeling of a tree and $f^{-1}(0) \in A$, then its boundary value is $\lambda = a - 1$.

Suppose that $f : V(G) \rightarrow \{0, 1, \dots, n\}$ is a graceful labeling of a graph G of size n :

- $\bar{f} : V(G) \rightarrow \{0, 1, \dots, n\}$, defined for every $v \in V(G)$ as $\bar{f}(v) = n - f(v)$, is the *complementary labeling* of f . Note that \bar{f} preserves the weights induced by f .
- $g : V(G) \rightarrow \{c, c+1, \dots, c+n\}$, defined for every $v \in V(G)$ and $c \in \mathbb{N}$ as $g(v) = c + f(v)$, is the *shifting* of f in c units. Note that this labeling preserves the weights induced by f .

Suppose now that f is an α -labeling of G with boundary value λ .

- $\hat{f} : V(G) \rightarrow \{0, 1, \dots, n\}$, defined for every $v \in V(G)$ as $\hat{f}(v) = \lambda - f(v)$ if $f(v) \leq \lambda$, and $\hat{f}(v) = n + \lambda + 1 - f(v)$ if $f(v) > \lambda$, is the *reverse labeling* of f . Note that \hat{f} is also an α -labeling with boundary value λ .
- $g : V(G) \rightarrow \mathbb{N}$, defined for every $v \in V(G)$ and any positive integer d as $g(v) = f(v)$ if $f(v) \leq \lambda$ and $g(v) = f(v) + d - 1$ if $f(v) > \lambda$, is the *d-graceful labeling* of G obtained from f . The labels assigned by g on the stable sets of $V(G)$ are in the intervals $[0, \lambda]$ and $[\lambda + d, n + d - 1]$ and the set of induced weights is $\{d, d + 1, \dots, n + d - 1\}$.

For example: let f be an α -labeling of a tree T of size n with boundary value λ . Suppose that f is transformed into a d -graceful labeling shifted c units. Then the elements of A are labeled with the integers in $[c, \lambda + c]$, the elements of B are labeled with the integers in $[c + \lambda + d, c + n + d - 1]$, and the induced weights form the interval $[d, n + d - 1]$.

Several graph operations involving graceful and/or α -graphs have been studied in the last fifty years. The Cartesian product has been extensively investigated for several families of graphs, as well as the union and the one-point union, the corona product, the join, the tensor product, and many other ways to combine graceful graphs to obtain new graceful and α -graphs. A good account of the newest techniques can be found in [11].

In Section 2 we perform series-parallel operations on α -graph to create new α -graphs; in addition, we prove that the one-point union of up to four copies of $K_{n,n}$ results in a new α -graph. In addition we present another example of a family of α -trees that can be constructed using the series operation. In Section 3 we show that any α -graph of order m and size n is an induced subgraph of an α -graph of order $m + 2$ and size $m + n$. We close this section showing that the Cartesian Product $K_{2,n} \times P_m$ is an α -graph for all positive values of m and n . The reader interested in graph labelings is referred to Gallian's survey [9] for more information about the subject. In this paper we follow the notation and terminology used in [8] and [9].

2 Series-Parallel Operations with α -Graphs

In this section we investigate how to operate α -graphs to produce larger α -graphs using the well-known series-parallel operations. We start analyzing the series operations, showing that we can always combine smaller α -graphs to produce new and larger α -graphs. As a consequence of this result we prove that the one-point union, of up-to four copies of $K_{n,n}$, is an α -graph. We also prove here that all trees with maximum degree 4, obtained applying the series operation to a collection of α -labeled copies of P_{11} , are α -graphs when the distance between any pair of consecutive vertices of degree 4 is even. The last part of the section is devoted to the study of the parallel operation on a family of α -graphs.

2.1 The Series Operation

A *series-parallel graph* with distinguished *terminals* l and r , denoted (G, l, r) , is defined recursively as follows:

- The graph consisting of a single edge v_1v_2 is a series-parallel graph (G, l, r) with $l = v_1$, and $r = v_2$.
- A series operation $(G_1, l_1, r_1) \odot_s (G_2, l_2, r_2)$ forms a series-parallel graph by identifying r_1 with l_2 .
- A parallel operation $(G_1, l_1, r_1) \odot_p (G_2, l_2, r_2)$ forms a series-parallel graph by identifying l_1 with l_2 and r_1 with r_2 .

Let f be an α -labeling of a graph G of size n with boundary value λ . Let $u, v \in V(G)$ such that $f(u) = \lambda + 1$ and $f(v) = n$. In the following result, these vertices correspond to the vertices l and r in the definition of series-parallel graph.

Theorem 2.1. *If G_1 and G_2 are α -graphs, then $(G_1, l_1, r_1) \odot_s (G_2, l_2, r_2)$ is an α -graph.*

Proof. For $i \in \{1, 2\}$, let G_i be an α -graph of size n_i . Suppose that f_i is an α -labeling of G_i with boundary value λ_i . The labels on G_1 are shifted $\lambda_2 + 1$ units; so, the new labels in G_1 are in the set $\{\lambda_2 + 1, \lambda_2 + 2, \dots, \lambda_1 + \lambda_2 + 1\} \cup \{\lambda_1 + \lambda_2 + 2, \lambda_1 + \lambda_2 + 3, \dots, n_1 + \lambda_2 + 1\}$, and the set of induced weights is still $\{1, 2, \dots, n\}$. The labeling of G_2 is transformed into a $(n_1 + 1)$ -graceful labeling. In this case, the labels in G_2 are in the set $\{0, 1, \dots, \lambda_2\} \cup \{n_1 + 1 + \lambda_2, n_1 + 2 + \lambda_2, \dots, n_1 + n_2\}$ and the set of induced weights is $\{n_1 + 1, n_1 + 2, \dots, n_1 + n_2\}$. Thus, both graphs have a vertex labeled $n_1 + 1 + \lambda_2$ that corresponds to the vertices r_1 of G_1 and l_2 of G_2 . The boundary value of the labeling of the new graph is $\lambda = \lambda_1 + \lambda_2 + 1$. \square

As a consequence of this result we can prove that the one-point union of up to four complete bipartite graphs $K_{n,n}$ is an α -graph. This result is related to some other problems that we can find in the literature. For example, in [15], Selvaraju worked with α -labelings of the one point union of complete bipartite graphs, showing that there is an α -labeling for the one-point union of the following graphs: K_{m,n_1} and K_{m,n_2} ; K_{m_1,n_1} , K_{m_2,n_2} , K_{m_3,n_3} when $m_1 \leq m_2 \leq m_3$ and $n_1 < n_2 < n_3$; and $K_{m_1,n}$, $K_{m_2,n}$, $K_{m_3,n}$ where $m_1 < m_2 < m_3 \leq 2n$. In a related line, Sethuraman and Selvaraju [16], proved that the one-point union of any number of non-isomorphic complete bipartite graphs is a graceful graph. Sudha [17] showed that the graph formed with any number of complete bipartite graphs that share one stable set, is graceful. Barrientos [5] proved that the graph obtained as the one-point union of K_{m_1,n_1} , K_{m_2,n_2} , \dots , K_{m_t,n_t} , where each K_{m_i,n_i} appears at most twice in that list and $\gcd(n_1, n_2, \dots, n_t) = 1$, is graceful.

Proposition 2.1. *For the one-point union of two copies of $K_{n,n}$, there exists an α -labeling that assigns the label $2n^2$ to the vertex of degree $2n$.*

Proof. Let $A = \{u_1, u_2, \dots, u_n\}$ and $B = \{v_1, v_2, \dots, v_n\}$ be the stable sets of $K_{n,n}$. Let f be the α -labeling of $K_{n,n}$ defined by $f(u_i) = i - 1$ and $f(v_i) = in$ for every $1 \leq i \leq n$. Thus, the boundary value of f is $n - 1$. Suppose that two copies of $K_{n,n}$ have been labeled using f . The labeling of the first copy of $K_{n,n}$ is transformed into a $(n^2 + 1)$ -graceful labeling. Hence, the induced weights are $n^2 + 1, n^2 + 2, \dots, 2n^2$ and the labels used form the sets $\{0, 1, \dots, n - 1\}$ and $\{n^2 + n, n^2 + 2n, \dots, 2n^2\}$. The labeling of the second copy of $K_{n,n}$ is transformed into its complementary labeling and then shifted $2n - 1$ units. In this way, the induced weights are $1, 2, \dots, n^2$ and the labels used form the sets $\{n^2 + n, n^2 + n + 1, \dots, n^2 + 2n - 1\}$ and $\{2n - 1, 3n - 1, \dots, n^2 + n - 1\}$.

Since the intersection between all these label sets is $n^2 + n$, we can identify the two vertices with this label to produce an α -labeled version of the one-point union of two copies of $K_{n,n}$, where $n^2 + n - 1$ is the boundary value of the associated α -labeling. Thus, the reverse labeling places the label $2n^2$ on the vertex of degree $2n$ that results of the amalgamation. \square

Consider now $K_{n,n}$ with the α -labeling described within the proof of Proposition 2.1, so, one of the stable sets of $K_{n,n}$ has a vertex labeled n and this is the smallest label in that

stable set. By Proposition 2.1, we know that there is an α -labeling, of the one-point union of two copies of $K_{n,n}$, that places the highest label, $2n^2$, on the vertex of maximum degree. Therefore we can apply Theorem 2.1 to prove that the one-point union of three copies of $K_{n,n}$ is an α -graph. On the case of the one-point union of four copies of $K_{n,n}$, we use Theorem 2.1 on two copies of the one-point union of two $K_{n,n}$. We start with two copies of the one-point union of two $K_{n,n}$ labeled using Proposition 2.1; once this is done, one of these labelings is transformed into its reverse labeling. In this way, the vertex of highest degree in the first copy is labeled $2n^2$ and in the second copy is labeled $n^2 + n - 1$. Hence Theorem 2.1 can be applied to prove the following theorem.

Theorem 2.2. *The one-point union of three or four copies of $K_{n,n}$ is an α -graph.*

In Figure 1 we show an example of these results for the case of $K_{3,3}$.

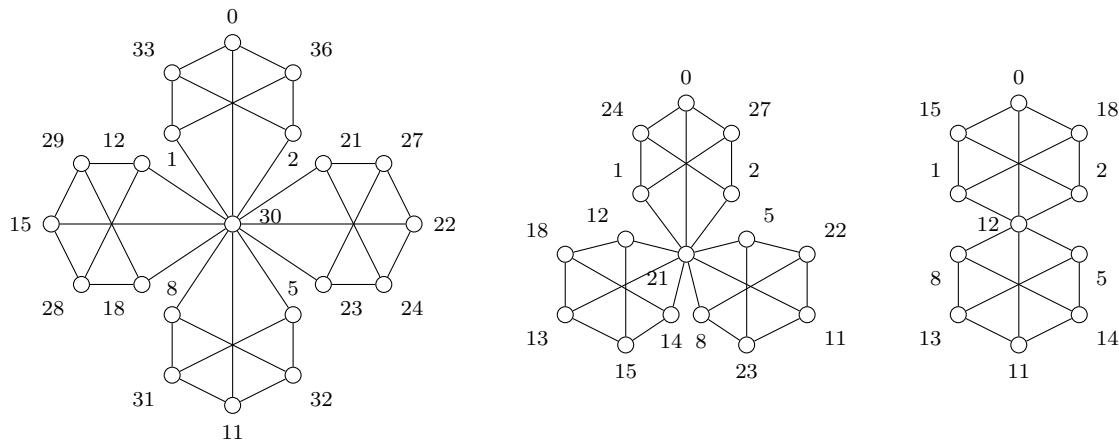

Figure 1: α -labeling of the one-point union of four, three, and two copies of $K_{3,3}$

2.2 A Chain of Paths Crossing: An Application

Suppose that for every $1 \leq i \leq t$, P^i is a path of length at least four with distinguished vertices v_1^i and v_2^i such that they are not leaves. A tree T is said to be a *chain of paths crossing* if for every $1 < i < t$, v_2^{i-1} is amalgamated with v_1^i and v_2^i is amalgamated with v_1^{i+1} . Thus, there are $t - 1$ crossings of paths (or vertices of degree 4) in T ; this implies that the order of T is $\sum_{i=1}^t |V(P^i)| - (t - 1) = \sum_{i=1}^t |V(P^i)| - t + 1$. Since the distinguished vertices, used in the amalgamation of P^i and P^{i+1} , are interior vertices, we may calculate the number of leaves in T (vertices of degree 1) to be $2t$. Therefore, the number of vertices of degree 3 is $\sum_{i=1}^t |V(P^i)| - 4t + 2$.

When the distinguished vertices are taken in an ad hoc manner, we can apply the series operation to produce an α -labeling of this type of tree. Rosa [12], proved that for every $v \in V(P_n)$, $n \geq 1$, there exists an α -labeling f of P_n such that $f(v) = 0$, except when v is the central vertex of P_5 . Thus, for a given path P_n , $n \geq 4$, with an α -labeling f , the distinguished vertices v_1 and v_2 are those where $f(v_1) = 0$ and $f(v_2) = \lambda$, where λ is the

boundary value of f . We want to show how powerful is the series operation, to do that, we work here with the case where the P^i are copies of P_{11} ; certainly the next result can be modified to include paths of other lengths.

Before presenting the theorem, let us introduce the α -labelings of P_{11} that are used in its proof. We show these labelings in Figure 2. On each path, we have highlighted the vertices labeled 0 and λ , which are crucial to apply the series operation.

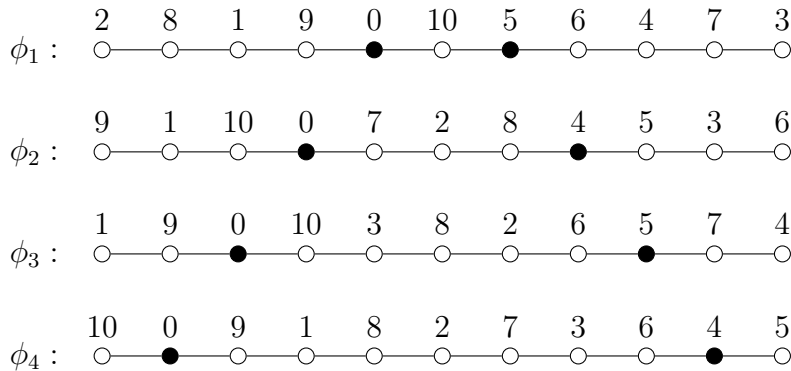

Figure 2: Different types of α -labelings of P_{11}

Theorem 2.3. *If T is a chain of paths crossing where every path is a copy of P_{11} and the distance between any pair of consecutive vertices of degree four is even, then T is an α -tree.*

Proof. Suppose that T is a chain of paths crossing formed with t copies of P_{11} in such a way that the distance between the distinguished vertices, v_1^i and v_2^i , of the i th copy of P_{11} is even, that is, $\text{dist}(v_1^i, v_2^i) \in \{2, 4, 6, 8\}$. Note that the labelings of P_{11} in Figure 2 can be used here because, for every $j \in \{1, 2, 3, 4\}$, under the labeling ϕ_j , $\text{dist}(v_1^i, v_2^i) = 2j$. The first and the last copy of P_{11} can be labeled with any of the labelings in Figure 2. For every $1 < i < t$, the labeling of the i th copy of P_{11} is determined by the distance between the distinguished vertices of P_{11} ; thus, if $\text{dist}(v_1^i, v_2^i) = 2j$, then the selected labeling is ϕ_j .

Assuming that the i th copy of P_{11} has been labeled, its initial α -labeling is amplified to produce a $(10i + 1)$ -graceful labeling; finally this transitory labeling must be shifted conveniently to produce the desired α -labeling of T . □

In Figure 3 we show an example of this construction for a tree T of size 60 where the sequence of distances, in between vertices of degree four, is 6, 4, 2, 8.

It may seem that this result does not contribute that much in the discovery of new graceful trees, however, it produces a large amount of them. In fact, for the case that we have under consideration, that is, for P_{11} , the number of non-isomorphic trees constructed with t copies of P_{11} is of the order of 2^{2t-1} .

Theorem 2.4. *Let $t \geq 3$ be an integer, the number of trees formed as a chain of t paths crossing, where every path used is isomorphic to P_{11} , and the distance between distinguished vertices belong to $\{2, 4, 6, 8\}$, is given by*

- (i) $2^{2t-1} + 2^t$ when t is odd,

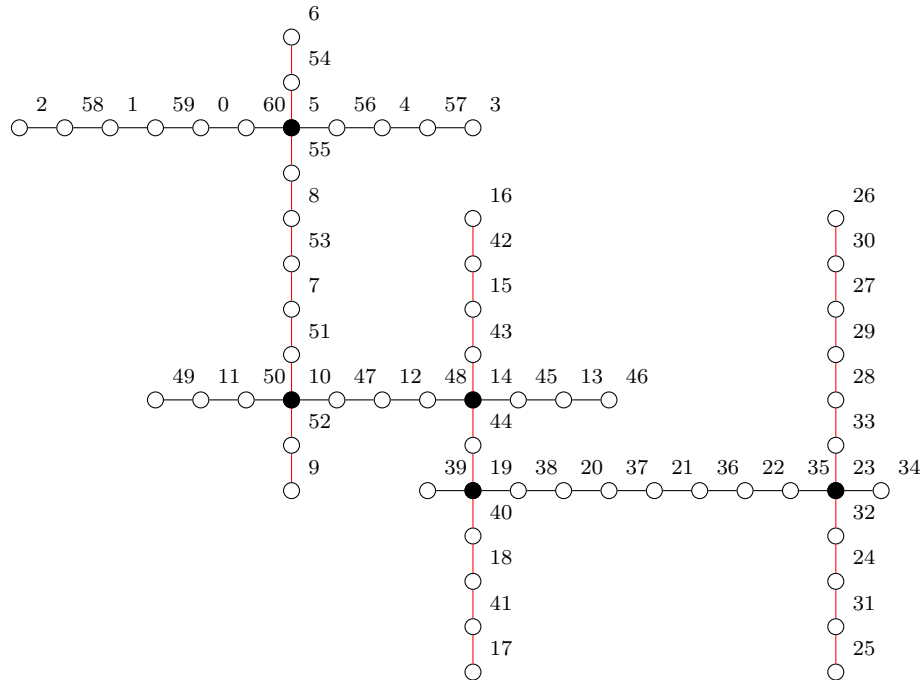

Figure 3: α -labeling of a chain of paths crossing

(ii) $2^{2t-1} + 2^{t-1}$ when t is even.

Proof. Let T be a tree that is a chain of paths crossing, formed using $t \geq 3$ copies of P_{11} such that the distance between consecutive vertices of degree four belongs to $D = \{2, 4, 6, 8\}$. Every copy of P_{11} is labeled with one of the labelings in Figure 2. Since we have four different α -labelings of P_{11} , there are 4^t different possibilities for T . Each of these α -labeled trees has associated a string of length $t - 2$, where every number on this string comes from D . But the string and its reverse represent the same tree and some strings are reversible, that is, they are the same when read backwards. So, in order to determine the number of different strings (or non-isomorphic trees formed in the prescribed way) we need to calculate the number of reversible strings.

When t is odd, there is an integer s such that $t - 2 = 2s + 1$. Thus, the number of reversible strings of length $t - 2$ is given by $(4^s)(4)(1^s)$, where the first factor is the number of strings of length s , the second factor is the amount of elements of D that can be placed in the median position of the string. The third factor is the number of options for the last s positions in the string; recall that these integers are determined by the selection made for the first s entries in the string. Thus, we have 4^{s+1} reversible strings of length $t - 2$. But this number does not consider the first and the last copy of P_{11} in T . So, the number of symmetric chains of t paths crossing is $4 \cdot 4^{s+1} = 4^{s+2}$. Hence, the number of non-isomorphic chains of t paths crossing is

$$\frac{1}{2}(4^t + 4^{s+2}) = \frac{1}{2}(2^{2t} + 2^{2s+4}) = \frac{1}{2}(2^{2t} + 2^{t+1}) = 2^{2t-1} + 2^t.$$

When t is even, there is an integer r such that $t - 2 = 2r$. Hence, the number of reversible

strings of length $t - 2$ is given by $(4^r)(1^r) = 4^r$. As in the odd case, the first factor is the number of strings of length r and the second factor is the number of options for the last r entries of the string. The number 4^r does not consider the first and the last copy of P_{11} in T . So, the number of symmetric chains of t paths crossing is $4 \cdot 4^r = 4^{r+1}$. Now the number of non-isomorphic chains of t paths crossing is

$$\frac{1}{2}(4^t + 4^{r+1}) = \frac{1}{2}(2^{2t} + 2^{2r+2}) = (2^{2t-1} + 2^{2r+1}) = 2^{2t-1} + 2^{t-1}.$$

This concludes the proof. □

Let $a(t)$ be the number of non-isomorphic trees T we can form in this way. In Table 1 we show the first values of $a(t)$, showing how fast this number grows. The sequence formed by the consecutive values of $a(t)$ corresponds to OEIS sequence A032121 [6].

t	3	4	5	6	7	8	9	10	11	12
$a(t)$	40	136	544	2080	8320	32896	131584	524800	2099200	8390656

Table 1: Number of non-isomorphic trees formed by a chain of paths crossing with t copies of P_{11}

2.3 The Parallel Operation

Now we turn our attention to graphs that can be constructed using the parallel operation. If G is an α -graph of size n , then G is bipartite. Let A and B be the stable sets of G , we assume that $|A| \leq |B|$. For $i = 1, 2$ let G_i be an α -graph of size n_i and let f_i be an α -labeling of G_i , with boundary value λ_i , such that the label λ_i is assigned to a vertex of A_i . We say that G_1 and G_2 are *compatible* if

- (i) the vertices x_i and y_i of G_i labeled 0 and λ_i are leaves and
- (ii) $n_1 = \lambda_1 + \lambda_2$.

We claim that the graph G obtained, using the parallel operation on G_1 and G_2 , is an α -graph.

Theorem 2.5. *If G_1 and G_2 are compatible graphs, then there exist vertices $x_1, y_1 \in G_1$ and $x_2, y_2 \in G_2$, such that $G = G_1 \odot_p G_2$ is an α -graph.*

Proof. For $i = 1, 2$, let $x_i, y_i \in V(G_i)$ such that $f_i(x_i) = 0$ and $f_i(y_i) = \lambda_i$. Let f'_1 be the labeling of the vertices of G_1 given by

$$f'_1(u) = \begin{cases} 0 & \text{if } u = y_1, \\ f_1(u) + \lambda_2 & \text{if } u \neq y_1 \text{ and } f(u) \leq \lambda_1, \\ f_1(u) + \lambda_2 - 1 & \text{if } u \neq y_1 \text{ and } f(u) > \lambda_1, \end{cases}$$

The labels assigned by f'_1 are in the set $\{0\} \cup \{\lambda_2, 1 + \lambda_2, \dots, \lambda_1 - 1 + \lambda_2\} \cup \{\lambda_1 + 1 + \lambda_2, \lambda_1 + 2 + \lambda_2, \dots, n_1 + \lambda_2\}$ and the induced weights form the set $\{1, 2, \dots, n_1\}$. The labeling

f_2 is transformed into a $(n_1 + 1)$ -graceful labeling, denoted f'_2 . Thus, the labels assigned by f'_2 are in the set $\{0, 1, \dots, \lambda_2\} \cup \{n_1 + 1 + \lambda_2, n_1 + 2 + \lambda_2, \dots, n_1 + n_2\}$ and the set of induced weights is $\{n_1 + 1, n_1 + 2, \dots, n_1 + n_2\}$.

Note that $f'_1(x_1) = \lambda_2$, $f'_1(y_1) = 0$, $f'_2(x_2) = 0$, and $f'_2(y_2) = \lambda_2$. Hence, when x_1 is identified with y_2 and y_1 is identified with x_2 , we obtain an α -labeling of $G = G_1 \odot_p G_2$ which boundary value is $\lambda = \lambda_1 + \lambda_2 - 1$. \square

Now we present a construction that produces compatible α -graphs. Suppose that G is an α -labeled graph of size n with an α -labeling f . If the vertex labeled 0 by f is not a leaf, then we create a graph G' by attaching a leaf to the vertex labeled n in G , in such a way that the new vertex is labeled 0 and all the other labels are increased by one unit, we obtain an α -labeling of G' where the vertex labeled 0 is a leaf. Something similar can be done to G if its labeling f does not assign the label λ to a leaf. In this case the new graph G'' , is obtained by attaching a leaf to the vertex labeled $\lambda + 1$. The α -labeling of G'' is obtained assigning the label $\lambda + 1$ to this leaf and adding one unit to each original label greater than λ . Clearly, if this does not assign the labels 0 and λ to leaves of G , a graph G''' can be formed applying these modifications. As an example, in Figure 4 we show, step by step, how the standard α -labeling of $G = C_8$ can be used to transform G into a self-compatible graph.

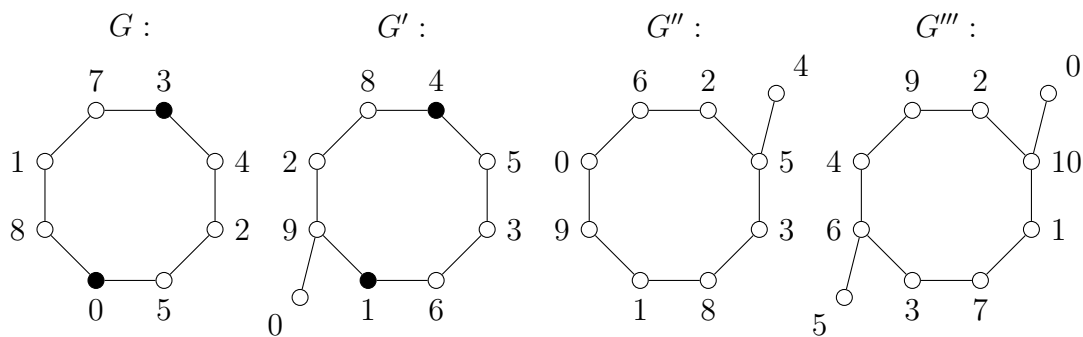

Figure 4: Creating compatible graphs

In Figure 5 we show some examples of the graphs obtained using the parallel operation on the cycles C_{16} , C_{12} , C_8 , and C_4 .

The family \mathcal{E} , of all caterpillars of even diameter, provides infinitely many pairs of compatible graphs. Rosa [13] proved that for any given caterpillar (or path), there exists an α -labeling f that assigns the label 0 to a vertex of maximum eccentricity, and in the case where the diameter is even, the vertex labeled λ (where λ is the boundary value of f) is the other extreme of the path of maximum length that has one extreme at the vertex labeled 0. So, for any given caterpillar X of size n in \mathcal{E} with stable sets of cardinalities a and b , any caterpillar X' in \mathcal{E} having one stable set of cardinality $n - a$ is compatible with X . Therefore, $X \odot_p X'$ is an α -graph. Note that the graph $X \odot_p X'$ is a type of unicyclic graph named *hairy cycle*; that is, a cycle with pendant vertices attached. In [4], Barrientos proved that all hairy cycles are graceful; when the girth of the cycle is even, the labeling used to prove that result is in fact an α -labeling.

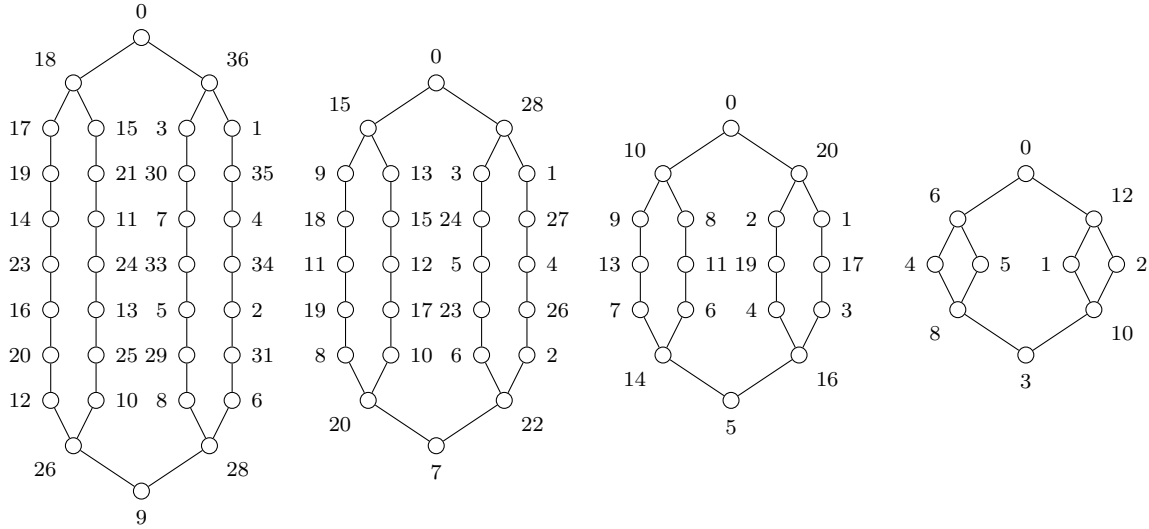

Figure 5: Parallel α -graphs obtained using modified cycles

3 α -Graphs Inside α -Graphs

In [2], it was proved that given a graceful graph G and an α -graph H , there is a vertex amalgamation of G and H that results in a graceful graph. This idea is a generalization of the quite natural construction of newer graceful graphs by attaching pendant vertices to the vertex labeled zero. In this section, we explore how to extend an α -labeled graph to a larger α -graph. Let G be an α -graph of order $n + 1$ and size n . As usual, we are assuming that there exists an α -labeling of G that assigns its boundary value to a vertex of the stable set A . We claim that there exists an α -graph H of size $2n + 1$ and order $n + 3$ that contains G as an induced subgraph.

In fact, let f be an α -labeling of G that assigns labels from the sets $\{0, 1, \dots, \lambda\}$ and $\{\lambda + 1, \lambda + 2, \dots, n\}$. So $|A| \leq \lambda + 1$ and $|B| \leq n - \lambda$.

If f is shifted $n - \lambda$ units, then the labels used are taken from $\{n - \lambda, n - \lambda + 1, \dots, n\}$ and $\{n + 1, n + 2, \dots, 2n - \lambda\}$. Once this is done we amplified this labeling by adding the constant $\lambda + 1$ to every vertex label in B , so the second set of labels becomes $\{n + \lambda + 2, n + \lambda + 3, \dots, 2n + 1\}$, and the set of induced weights is $\{\lambda + 2, \lambda + 3, \dots, n + \lambda + 1\}$.

A new vertex, labeled $n + 1$, is connected with every vertex in A , inducing the weights $\lambda + 1, \lambda, \dots$, and 1. Another new vertex, labeled 0, is connected with every vertex in B , inducing the weights $n + \lambda + 2, n + \lambda + 3, \dots, 2n + 1$.

Therefore, we have a graph of order $n + 3$, size $2n + 1$, together with a labeling that assigns the labels from $\{0, 1, \dots, 2n + 1\}$ and induces the weights $\{1, 2, \dots, \lambda + 1, \lambda + 2, \lambda + 3, \dots, n + \lambda + 1, n + \lambda + 2, n + \lambda + 3, \dots, 2n + 1\}$. In addition, since the vertex label 0 is attached to the vertices in B and the vertex labeled $n + 1$ is attached to the vertices in A , this is an α -labeling with boundary value n . In this way we have proven the following theorem.

Theorem 3.1. *For each α -graph G of order $n + 1$ and size n , there exists an α -graph H of order $n + 3$ and size $2n + 1$, such that G is an induced subgraph of H .*

In Figure 6 we show two examples of this procedure. In the first case G is a caterpillar of size 8; in the second case, G is a disconnected α -graph of size 7.

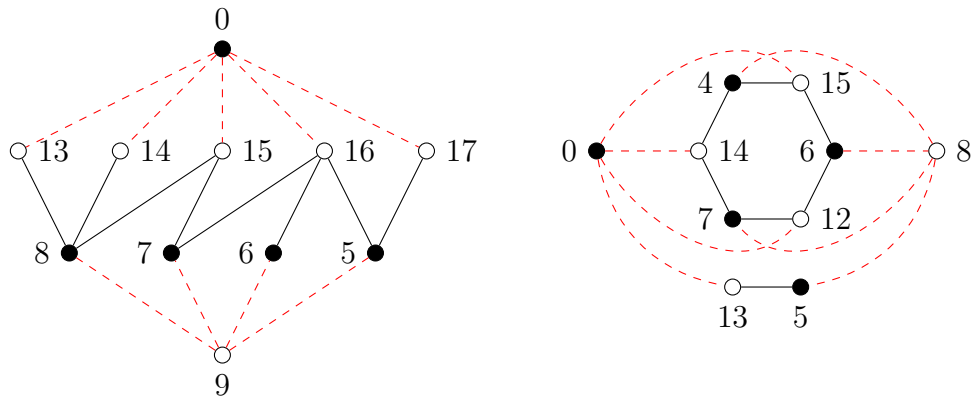

Figure 6: α -labelings of graphs containing smaller α -graphs

Using the construction of α -graphs just presented, many other graphs of this type can be obtained. To explain this statement we can analyze the first graph in Figure 6. There, the edges are located in three levels: level 1 contains the edges incident to the vertex labeled 0, level 2 contains the edges of G , and level 3 contains the edges incident to the vertex labeled 9 (or $\lambda + 1$ in a more general version). We can delete some of the edges in levels 1 and 3 and still have an α -graph; if we delete, from left to right, any number of consecutive edges of level 1, and from right to left, any number of consecutive edges on level 3, then the labeling of the resulting graph can be transformed into an α -labeling. We illustrate this fact in Figure 7.

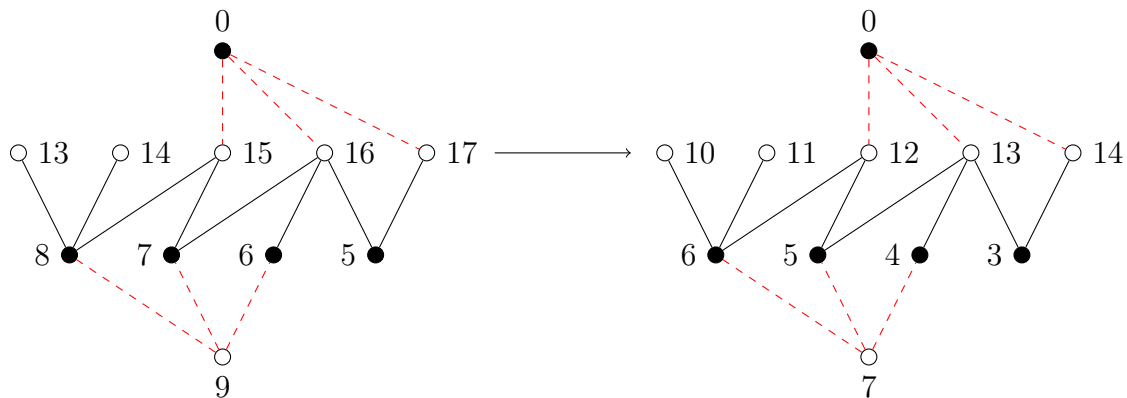

Figure 7: A way to obtain smaller α -graphs

4 An α -labeling of $K_{2,n} \times P_m$

In this section we present a new family of α -graphs that are the result of the Cartesian product of $K_{2,n}$ and P_m . The graph $K_{2,n} \times P_m$ has order $m(n+2)$ and size $3mn + 2m - n - 2$. In the next theorem we use the following well-known α -labelings of $K_{2,n}$. First, suppose that $A = \{u_1, u_2\}$ and $B = \{v_1, v_2, \dots, v_n\}$ are the stable sets of $K_{2,n}$:

- $f(u_1) = 0, f(u_2) = n,$ and $f(v_i) = n + i$ for all $1 \leq i \leq n$.
- $g(u_1) = 2n, g(u_2) = 2n - 1,$ and $g(v_i) = 2(i - 1)$ for all $1 \leq i \leq n$.

Essentially these labelings are adaptations of the α -labeling of $K_{m,n}$ introduced by Rosa [13].

Theorem 4.1. *For all positive values of m and n , the graph $K_{2,n} \times P_m$ is an α -graph.*

Proof. Let R_1, R_2, \dots, R_m be the m copies of $K_{2,n}$ in $K_{2,n} \times P_m$. The stable sets of $R_j, 1 \leq j \leq m,$ are $A_j = \{u_1^j, u_2^j\}$ and $B_j = \{v_1^j, v_2^j, \dots, v_n^j\}$. Suppose that the initial labeling of R_j is f when j is odd and g when j is even. Regardless of the parity of j , this initial labeling is transformed into a δ_j -graceful labeling shifted ϵ_j units, where $\delta_j = (3n + 2)(m - j) + 1$ and

$$\epsilon_j = \begin{cases} (3n + 2)(j - 1)/2 & \text{if } j \text{ is odd,} \\ (3n + 2)(j - 2)/2 + n + 2 & \text{if } j \text{ is even.} \end{cases}$$

Assume that j is even. The new labels of the vertices in A_j and B_j form the sets

$$L_{A_j} = \{(3n + 2)(2m - j)/2, (3n + 2)(2m - j)/2 - 1\}$$

and

$$L_{B_j} = \{(3n + 2)(j - 2)/2 + n + 2i : 1 \leq i \leq n\},$$

respectively.

For $j - 1$ and $j + 1$, if R_{j+1} exists, we get the following sets:

$$\begin{aligned} L_{A_{j-1}} &= \{(3n + 2)(j - 2)/2, (3n + 2)(j - 2)/2 + n\}, \\ L_{B_{j-1}} &= \{(3n + 2)(2m - j)/2 + n + 1 : 1 \leq i \leq n\}, \\ L_{A_{j+1}} &= \{(3n + 2)j/2, (3n + 2)j/2 + n\}, \\ L_{B_{j+1}} &= \{(3n + 2)(2m - j - 2)/2 + n + 1 : 1 \leq i \leq n\}. \end{aligned}$$

Since $\max L_{A_{j-1}} < \min L_{B_j} \leq \max L_{B_j} < \min L_{A_{j+1}}$ and $\min L_{B_{j-1}} > \max L_{A_j} > \min L_{A_j} > \max L_{B_{j+1}}$, we conclude that we have an injective assignment of labels. Furthermore, the smallest label assigned is $\min L_{A_{2-1}} = 0$ and the largest one is $\max L_{B_{2-1}} = (3n + 2)(2m - 2)/2 + n + n = 3mn + 2m - n - 2$.

Now we turn our attention to the weights induced by this labeling on the edges of $K_{2,n} \times P_m$. Let h denote the labeling of our graph. As we said before, when h is restricted to R_j ,

$1 \leq j \leq m$, it is an amplification of an α -labeling, so the weights on the edges of $K_{2,n} \times P_m$ form the set

$$W_{R_j} = \{(3n + 2)(m - j) + i : 1 \leq i \leq 2n\}.$$

Note that for every $2 \leq j \leq m$, $\min W_{R_{j-1}} - \max W_{R_j} = n + 3$.

One more time, suppose that j is even. Then, for every $1 \leq i \leq n$,

$$\begin{aligned} h(u_1^j) - h(u_1^{j-1}) &= (3n + 2)(2m - j)/2 - (3n + 2)(j - 2)/2 \\ &= (3n + 2)(m - j + 1), \\ h(u_2^j) - h(u_2^{j-1}) &= (3n + 2)(2m - j)/2 - 1 - (3n + 2)(j - 2)/2 - n \\ &= (3n + 2)(m - j + 1) - (n + 1), \\ h(v_1^{j-1}) - h(v_1^j) &= (3n + 2)(2m - j)/2 + n + i - (3n + 2)(j - 2)/2 - n - 2i \\ &= (3n + 2)(m - j + 1) - i. \end{aligned}$$

Hence, the weights of the edges connecting R_{j-1} and R_j form the set

$$W_{j-1,j} = \{(3n + 2)(m - j + 1) - k : 0 \leq k \leq n + 1\}$$

and

$$W_{R_{j-1}} \cup W_{j-1,j} = [(3n + 2)(m - j + 1) - n - 1, (3n + 2)(m - j + 1) + 2n].$$

On the other side, and assuming that j is even, for every $1 \leq i \leq n$, we get

$$\begin{aligned} h(u_1^j) - h(u_1^{j+1}) &= (3n + 2)(2m - j)/2 - (3n + 2)j/2 \\ &= (3n + 2)(m - j), \\ h(u_2^j) - h(u_2^{j+1}) &= (3n + 2)(2m - j)/2 - 1 - (3n + 2)j/2 - n \\ &= (3n + 2)(m - j) - (n + 1), \\ h(v_i^{j+1}) - h(v_1^j) &= (3n + 2)(2m - j - 2)/2 + n + i - (3n + 2)(j - 2)/2 - n - 2i \\ &= (3n + 2)(m - j) - i. \end{aligned}$$

The weights of the edges connecting R_j and R_{j+1} form the set

$$W_{j,j+1} = \{(3n + 2)(m - j) - k : 0 \leq k \leq n + 1\}$$

and

$$W_{R_j} \cup W_{j,j+1} = [(3n + 2)(m - j) - n - 1, (3n + 2)(m - j) + 2n].$$

Since $\min(W_{R_{j-1}} \cup W_{j-1,j}) - \max(W_{R_j} \cup W_{j,j+1}) = ((3n + 2)(m - j + 1) - n - 1) - ((3n + 2)(m - j) + 2n) = 1$, we can see that every weight appears exactly once. In addition, the largest weight, obtained on R_1 , equals $(3n + 2)(m - 2 + 1) + 2n = 3mn + 2m - n - 2$, which is the size of the graph. Recall that the weight 1 is obtained on R_m because when h is restricted to R_m , h is just a shifting of an α -labeling.

Since the bipartite nature of the initial α -labelings of the R_j is not affected by any of the transformations applied to them and the fact that when one stable set of R_j has the largest labels, the corresponding stable set on R_{j+1} has the smallest labels assigned to the $(j + 1)$ th copy of $K_{2,n}$. Hence, the labeling h of $K_{2,n} \times P_m$ is bipartite with boundary value

$$\lambda = \begin{cases} n + (3n + 2)(m - 1)/2 & \text{if } m \text{ is odd,} \\ (3n + 2)m/2 - 2 & \text{if } m \text{ is even.} \end{cases}$$

In addition, $\min\{h(v) : v \in V(K_{2,n} \times P_m)\} = 0$ and $\max\{h(v) : v \in V(K_{2,n} \times P_m)\} = 3mn + 2m - n - 2$. Therefore, h is an α -labeling of $K_{2,n} \times P_m$. \square

In Figure 8 we show an example for the case $K_{2,7} \times P_4$.

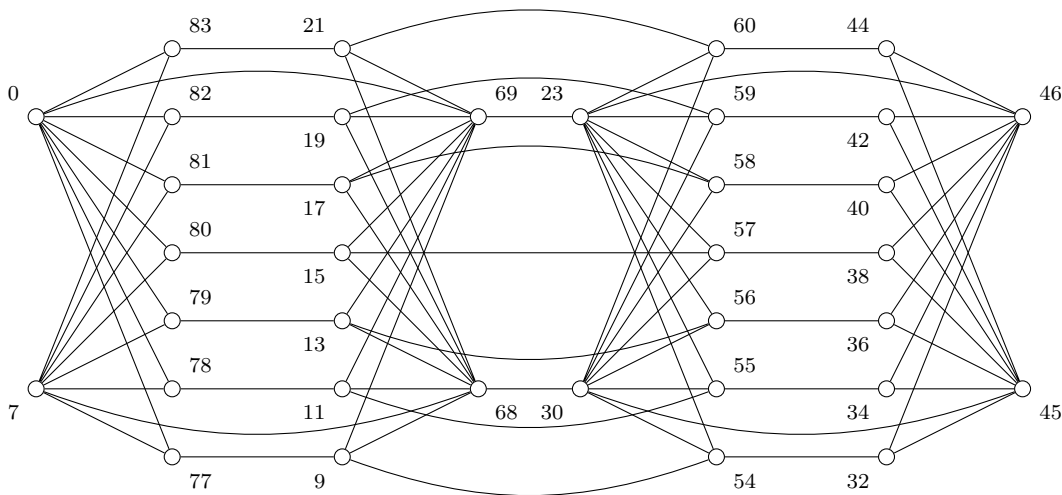

Figure 8: α -labeling of $K_{2,7} \times P_4$

5 Conclusions

The two operations introduced in this work can be used to find new families of graceful or α -graphs. The series operation was used here to prove that any tree that is a chain of t paths crossing, where the paths are isomorphic to P_{11} and the distance between any pair of vertices of degree 4 is even. In this context we can ask the following: if T is any chain of t paths crossing, is T an α -tree? In other terms, can we obtain an α -tree independently of the parity of the distance between any pair of vertices of degree 4? Also, if not all the paths used in T are isomorphic, is the result still valid? Aldred, Širáň, and Širáň [1] proved that the number of graceful labelings of P_n grows at least as fast as $(\frac{5}{3})^n$; Cattell [7] proved that in the majority of the cases, for any vertex v in P_n and any label $r \in \{0, 1, \dots, n - 1\}$, there exists a graceful labeling f of P_n such that $f(v) = r$. These two results together with Rosa's result [12], provide support to our idea that all trees that are a chain of paths crossing, are

in fact α -trees, regardless of the paths used and the parity between consecutive crossings (vertices of degree 4).

In order to apply the parallel operation, we just need two compatible graphs. In the example given in Figure 5, the cycles can be replaced by any graph obtained identifying the corresponding end-vertices of any number of paths of even size, the labeling of the new parallel graph follows the same pattern that the one exhibited in Figure 5. We can also apply the parallel operation to any pair of compatible path-like trees, defined by Barrientos in [3] (these trees are called T_P by Hegde and Shetty [10]), because their α -labelings are based on Rosa's α -labelings of caterpillars [13]. Thus, when the diameter of these trees is even, the labels 0 and λ are placed in the extreme vertices of a path of maximum length; the resulting graph is, as in the case of the caterpillars mentioned in Section 2, a unicyclic α -graph. In this way we obtain more evidence that support Truszczyński's conjecture [18] that all unicyclic graphs are graceful.

Finally, we have three questions related to Theorem 4.1, where we proved that the Cartesian product of $K_{2,n}$ and P_m is an α -graph. For which values of n_1 , is the graph $K_{n_1,n_2} \times P_m$ an α -graph? Let T_m be any tree of order m . Is $K_{2,n} \times T_m$ an α -graph? Is $K_{n_1,n_2} \times T_m$ an α -graph?

6 Acknowledgment

We want to thank the referees for their comments, suggestions, and fine work, that certainly helped us to improve the quality of this paper.

References

- [1] R. E. L. Aldred, J. Širáň and M. Širáň. A note on the number of graceful labelings of paths. *Discrete Math.*, 261:27–30, 2003.
- [2] C. Barrientos. Graceful labelings of chain and corona graphs. *Bull. Inst. Combin. Appl.*, 34:17–26, 2002.
- [3] C. Barrientos. *Difference Vertex Labelings*, Ph.D. Thesis. Universitat Politècnica de Catalunya, Barcelona, 2004.
- [4] C. Barrientos. Graceful graphs with pendant edges. *Australas. J. Combin.*, 33:99–107, 2005.
- [5] C. Barrientos. Graceful arbitrary supersubdivisions of graphs. *Indian J. Pure Appl. Math.*, 38:445–450, 2007.
- [6] C. G. Bower, <https://oeis.org/A032121>, 2017.
- [7] R. Cattell. Graceful labellings of paths. *Discrete Math.*, 307:3161–3176, 2007.
- [8] G. Chartrand and L. Lesniak. *Graphs & Digraphs*, 2nd ed., Wadsworth & Brooks/Cole (1986).

- [9] J. A. Gallian. A dynamic survey of graph labeling. *Electronic J. Combin.*, 20(#DS6.), 2017.
- [10] S. M. Hegde and S. Shetty. On graceful trees. *Appl. Math. E-Notes.*, 2:192–197, 2002.
- [11] S. C. López and F. A. Muntaner-Batle. *Graceful, Harmonious and Magic Type Labelings*, 2017. Springer Briefs in Mathematics, Cham, Switzerland.
- [12] A. Rosa. Labeling snakes. *Ars Combin.*, 3:67–73, 1977.
- [13] A. Rosa. On certain valuations of the vertices of a graph. *Theory of Graphs (Internat. Symp., Rome, July 1966)*, 349–355, 1967.
- [14] A. Rosa and J. Širáň. Bipartite labelings of trees and the gracesize. *J. Graph Theory*, 19:201–215, 1995.
- [15] P. Selvaraju. *New classes of graphs with α -valuation, harmonious and cordial labelings*. Ph. D. Thesis. Anna University, 2001. Madurai Kamaraj University, 2002.
- [16] G. Sethuraman and P. Selvaraju. On graceful graphs I: Union of non-isomorphic complete bipartite graphs with one vertex in common. *J. Combin. Inform. System Sci.*, 26:23–32, 2001.
- [17] S. Sudha. Gracefulness of joining complete bipartite graphs having a common vertex set. *Engin. Sci. Internat. Research J.*, 1 (1):84–85, 2013.
- [18] M. Truszczyński. Graceful unicyclic graphs. *Demonstratio Mathematica*, 17:377–387, 1984.